



## Garrison Assembly Instructions

(Registered Design 4002675) Please retain this document for future reference.

**Please fold all creases well prior to assembly of toy and ensure all parts are securely connected.**

### Assembled Garrison

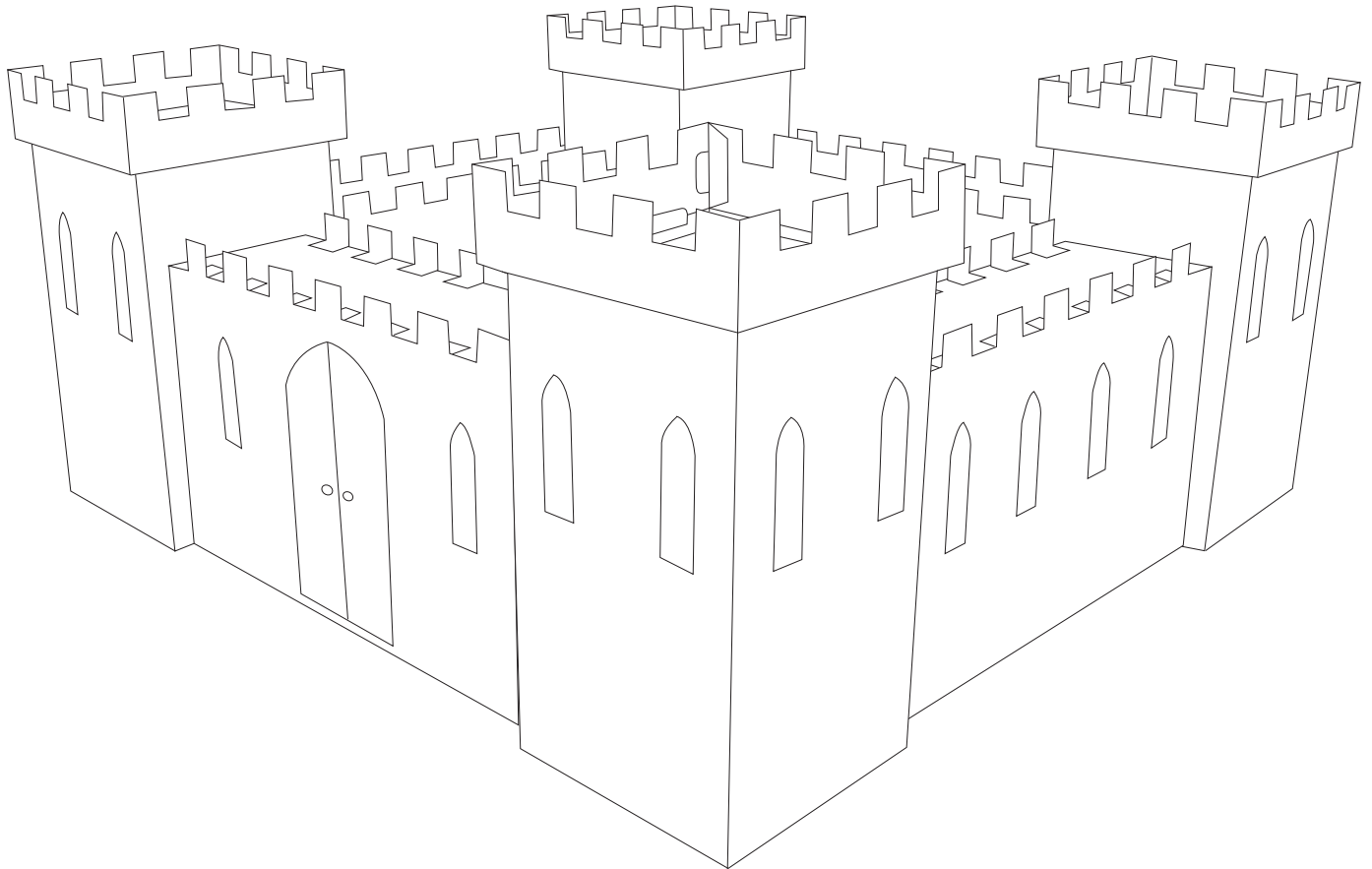

The garrison is designed primarily for indoor use but is also suitable for outdoor use in dry, calm conditions. The garrison should be stored in a dry place and should be kept away from fire or any naked flame. The garrison should be inspected regularly before, during and after use for any signs of damage, which could cause potential injury.

**WARNING :** This product should be kept out of the reach of very young children and only be used under the direct supervision of an adult.

[www.cardboardtoys.com](http://www.cardboardtoys.com)

**Postpack Ltd T/A Kid-Eco**

Units 1,2 & 4, Hollis Road, Grantham, Lincs. NG31 7QH  
tel: 0845 071 0761 | fax: 0845 071 0766 | email: [sales@kideco.co.uk](mailto:sales@kideco.co.uk)



## Garrison Assembly Instructions

(Registered Design 4002675) Please retain this document for future reference.

Please fold all creases well prior to assembly of toy and ensure all parts are securely connected.

### Step 1

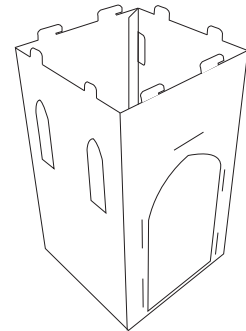
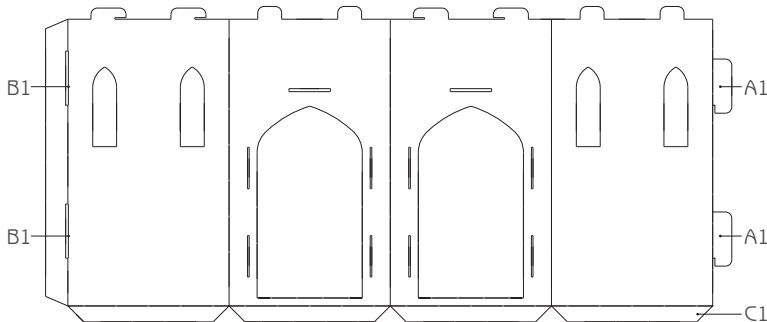

Turret Base  
(4 off)

- Insert tabs (A1) into slots (B1) at opposite end of turret base and gently pull down to lock into place.
- Fold flaps (C1) inwards for stability.

### Step 2

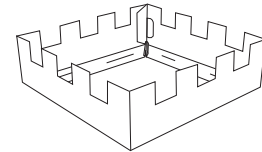
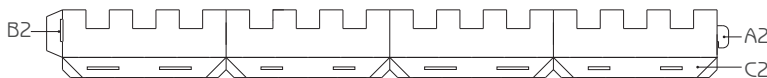

Turret Top  
(4 off)

- Insert tab (A2) into slot (B2) at opposite end of turret top and gently pull down to lock into place.
- Fold flaps (C2) under, ensuring corner tabs are on the inside.

### Step 3

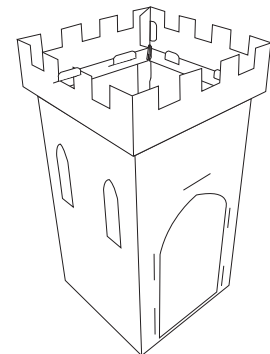
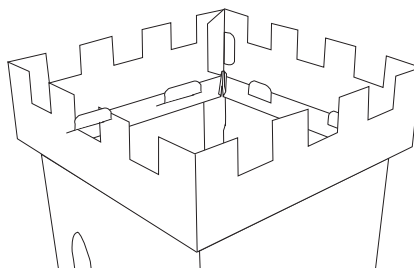
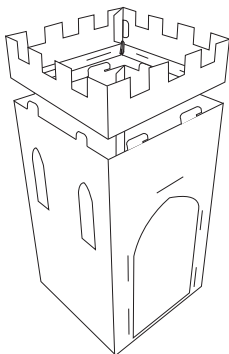

Assembled  
Turret

- Align the larger slots in the turret top with the larger tabs on the turret base and the smaller slots with the smaller tabs.
- Gently push down until turret top is firmly attached to base. The turret is now complete.
- Repeat for all 4 turrets.

The garrison is designed primarily for indoor use but is also suitable for outdoor use in dry, calm conditions. The garrison should be stored in a dry place and should be kept away from fire or any naked flame. The garrison should be inspected regularly before, during and after use for any signs of damage, which could cause potential injury.

**WARNING :** This product should be kept out of the reach of very young children and only be used under the direct supervision of an adult.



## Garrison Assembly Instructions

(Registered Design 4002675) Please retain this document for future reference.

Please fold all creases well prior to assembly of toy and ensure all parts are securely connected.

### Step 4

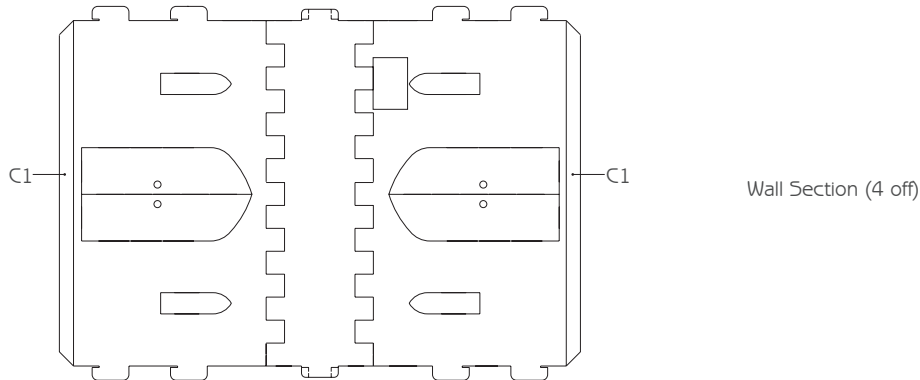

- Fold flaps (C1) inwards for stability.

### Step 5

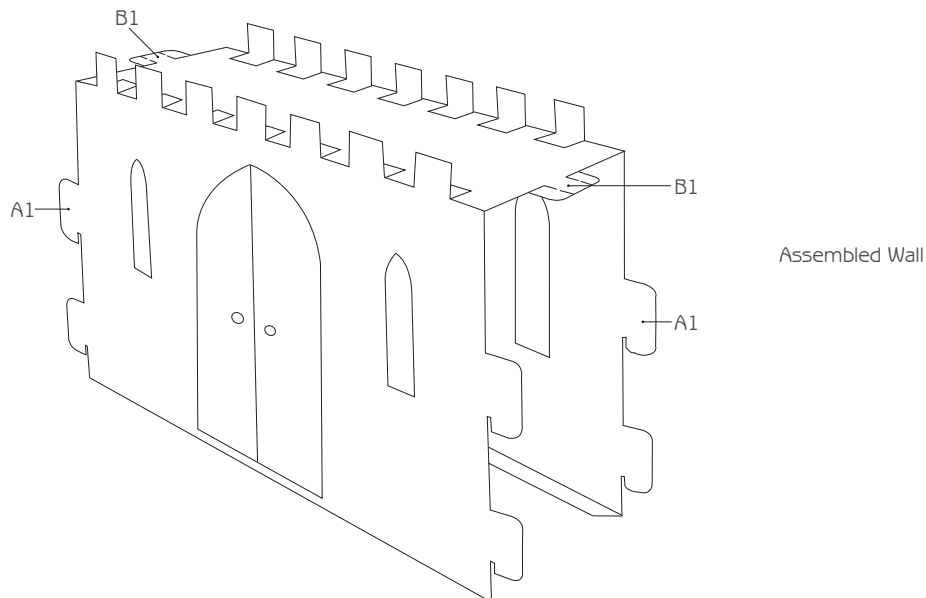

The garrison is designed primarily for indoor use but is also suitable for outdoor use in dry, calm conditions. The garrison should be stored in a dry place and should be kept away from fire or any naked flame. The garrison should be inspected regularly before, during and after use for any signs of damage, which could cause potential injury.

**WARNING :** This product should be kept out of the reach of very young children and only be used under the direct supervision of an adult.

[www.cardboardtoys.com](http://www.cardboardtoys.com)

Postpack Ltd T/A Kid-Eco

Units 1,2 & 4, Hollis Road, Grantham, Lincs. NG31 7QH  
tel: 0845 071 0761 | fax: 0845 071 0766 | email: sales@kideco.co.uk

